

SODDERLUG DETAIL
SCALE 2X

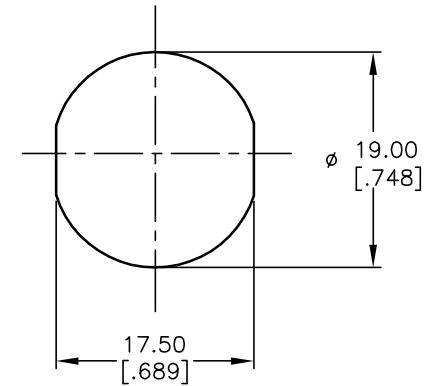

RECOMMENDED PANEL CUTOUT

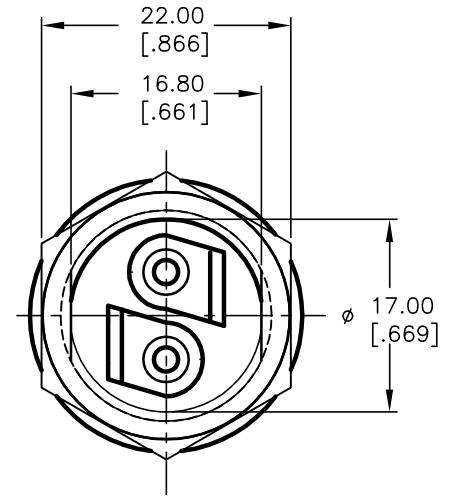
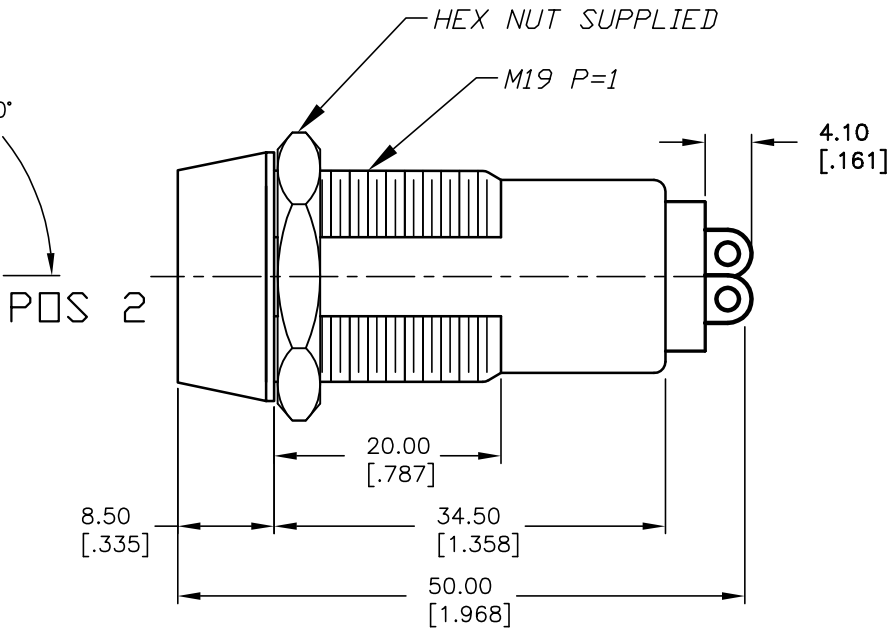
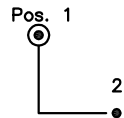

CIRCUIT: SPST
CONTACT CONFIGURATION

SWITCH FUNCTION	
POS 1	POS 2
↑	→
OFF	ON

LEGEND

- = INDICATE NO KEY PULL
- ⊙ = INDICATES KEY PULL POSSIBLE

NOTES:

1. ALL DIMENSIONS IN MM [INCH]
2. GENERAL TOLERANCE: X.X=±0.4
X.XX=±0.25
3. TERM. NOS. FOR REFERENCE ONLY.
4. RATING: 4A @125VAC, 2A @250VAC
5. CONTACT RESISTANCE: 10mILLI-OHMS
6. DIELECTRIC STRENGTH: 1500 VAC-1Minute
7. INSULATION RESISTANCE: 500 Mega-OHMS
8. MATERIALS:

HOUSING: ZINC ALLOY DIE CAST
CYLINDER: ZINC ALLOY W/CHROME PLATING
TERMINAL AND CONTACTS: SILVER PLATED
TUMBLER: 5 DISC MECHANISM W/DUST SHUTTER
KEYS 7304 (2): BRASS W/NICKEL PLATING
DOUBLE CUT REVERSIBLE

E-SWITCH®

A	14089	RELEASED FOR PRODUCTION	6/10/04	AR
REV.	ECN No.	DESCRIPTION	DATE	CHKD

TITLE				
K0119A-7304				
SCALE	DATE	DR	DWG	REV
1.5:1	6/10/04	AR	K200134	A

THE INFORMATION CONTAINED IN THIS DOCUMENT
IS PROPRIETARY TO E-SWITCH AND IS
NOT TO BE COPIED OR TRANSFERRED