

# HiPerFET™ Power MOSFETs Q-Class

**IXFH 17N80Q**  
**IXFT 17N80Q**

$V_{DSS} = 800\text{ V}$   
 $I_{D25} = 17\text{ A}$   
 $R_{DS(on)} = 0.60\ \Omega$

$t_{rr} \leq 250\text{ ns}$

N-Channel Enhancement Mode  
Avalanche Rated, High dv/dt, Low  $Q_g$

Preliminary Data Sheet

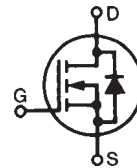

Symbol	Test Conditions	Maximum Ratings
$V_{DSS}$	$T_J = 25^\circ\text{C to } 150^\circ\text{C}$	800 V
$V_{DGR}$	$T_J = 25^\circ\text{C to } 150^\circ\text{C}; R_{GS} = 1\text{ M}\Omega$	800 V
$V_{GS}$	Continuous	$\pm 20$ V
$V_{GSM}$	Transient	$\pm 30$ V
$I_{D25}$	$T_C = 25^\circ\text{C}$	17 A
$I_{DM}$	$T_C = 25^\circ\text{C}$ , pulse width limited by $T_{JM}$	68 A
$I_{AR}$	$T_C = 25^\circ\text{C}$	17 A
$E_{AR}$	$T_C = 25^\circ\text{C}$	30 mJ
$E_{AS}$	$T_C = 25^\circ\text{C}$	1.0 J
dv/dt	$I_S \leq I_{DM}$ , $di/dt \leq 100\text{ A}/\mu\text{s}$ , $V_{DD} \leq V_{DSS}$ , $T_J \leq 150^\circ\text{C}$ , $R_G = 2\ \Omega$	5 V/ns
$P_D$	$T_C = 25^\circ\text{C}$	400 W
$T_J$		-55 ... +150 °C
$T_{JM}$		150 °C
$T_{stg}$		-55 ... +150 °C
$T_L$	1.6 mm (0.062 in.) from case for 10 s	300 °C
$M_d$	Mounting torque	1.13/10 Nm/lb.in.
Weight	TO-247	6 g
	TO-268	4 g

### TO-268 (D3) (IXFT) Case Style

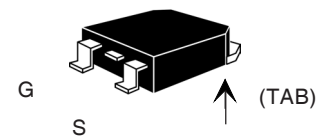

### TO-247 AD (IXFH)

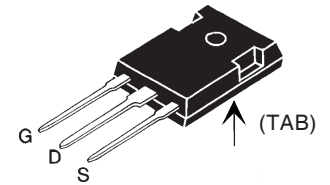

G = Gate      D = Drain  
S = Source      TAB = Drain

Symbol	Test Conditions ( $T_J = 25^\circ\text{C}$ , unless otherwise specified)	Characteristic Values		
		Min.	Typ.	Max.
$V_{DSS}$	$V_{GS} = 0\text{ V}$ , $I_D = 3\text{ mA}$	800		V
$V_{GS(th)}$	$V_{DS} = V_{GS}$ , $I_D = 4\text{ mA}$	2.0		V
$I_{GSS}$	$V_{GS} = \pm 20\text{ V}_{DC}$ , $V_{DS} = 0$			$\pm 100$ nA
$I_{DSS}$	$V_{DS} = V_{DSS}$ , $T_J = 25^\circ\text{C}$			25 $\mu\text{A}$
	$V_{GS} = 0\text{ V}$ , $T_J = 125^\circ\text{C}$			1 mA
$R_{DS(on)}$	$V_{GS} = 10\text{ V}$ , $I_D = 0.5 I_{D25}$ Pulse test, $t \leq 300\ \mu\text{s}$ , duty cycle $d \leq 2\%$			0.60 $\Omega$

### Features

- IXYS advanced low  $Q_g$  process
- International standard packages
- Low  $R_{DS(on)}$
- Unclamped Inductive Switching (UIS) rated
- Fast switching
- Molding epoxies meet UL 94 V-0 flammability classification

### Advantages

- Easy to mount
- Space savings
- High power density

Symbol	Test Conditions	Characteristic Values		
		(T <sub>J</sub> = 25°C, unless otherwise specified)		
		Min.	Typ.	Max.
<b>g<sub>fs</sub></b>	V <sub>DS</sub> = 10 V; I <sub>D</sub> = 0.5 I <sub>D25</sub> , pulse test	9	17	S
<b>C<sub>iss</sub></b>	V <sub>GS</sub> = 0 V, V <sub>DS</sub> = 25 V, f = 1 MHz		3600	pF
<b>C<sub>oss</sub></b>			350	pF
<b>C<sub>rss</sub></b>			100	pF
<b>t<sub>d(on)</sub></b>	V <sub>GS</sub> = 10 V, V <sub>DS</sub> = 0.5 V <sub>DSS</sub> , I <sub>D</sub> = 0.5 I <sub>D25</sub> R <sub>G</sub> = 1.5 Ω (External)		18	ns
<b>t<sub>r</sub></b>			27	ns
<b>t<sub>d(off)</sub></b>			53	ns
<b>t<sub>f</sub></b>			16	ns
<b>Q<sub>g(on)</sub></b>	V <sub>GS</sub> = 10 V, V <sub>DS</sub> = 0.5 V <sub>DSS</sub> , I <sub>D</sub> = 0.5 I <sub>D25</sub>		95	nC
<b>Q<sub>gs</sub></b>			20	nC
<b>Q<sub>gd</sub></b>			40	nC
<b>R<sub>thJC</sub></b>	(TO-247)		0.31	K/W
<b>R<sub>thCK</sub></b>			0.25	K/W

Symbol	Test Conditions	Characteristic Values		
		(T <sub>J</sub> = 25°C, unless otherwise specified)		
		min.	typ.	max.
<b>I<sub>S</sub></b>	V <sub>GS</sub> = 0 V			15 A
<b>I<sub>SM</sub></b>	Repetitive;			60 A
<b>V<sub>SD</sub></b>	I <sub>F</sub> = I <sub>S</sub> , V <sub>GS</sub> = 0 V, Pulse test, t ≤ 300 μs, duty cycle d ≤ 2 %			1.5 V
<b>t<sub>rr</sub></b>	I <sub>F</sub> = I <sub>S</sub> -di/dt = 100 A/μs, V <sub>R</sub> = 100 V		0.85	250 ns
<b>Q<sub>RM</sub></b>				8 μC
<b>I<sub>RM</sub></b>				

### Min Recommended Footprint

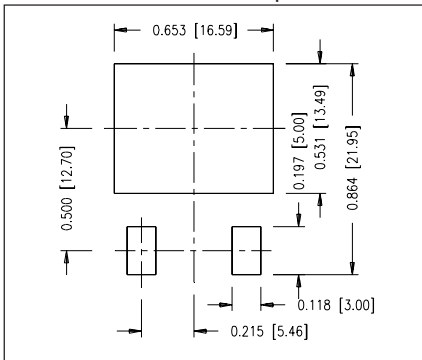

### TO-247 AD Outline

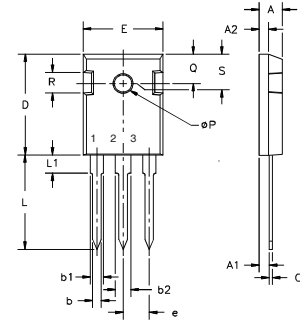

Terminals: 1 - Gate    2 - Drain  
3 - Source    Tab - Drain

Dim.	Millimeter		Inches	
	Min.	Max.	Min.	Max.
A	4.7	5.3	.185	.209
A <sub>1</sub>	2.2	2.54	.087	.102
A <sub>2</sub>	2.2	2.6	.059	.098
b	1.0	1.4	.040	.055
b <sub>1</sub>	1.65	2.13	.065	.084
b <sub>2</sub>	2.87	3.12	.113	.123
C	.4	.8	.016	.031
D	20.80	21.46	.819	.845
E	15.75	16.26	.610	.640
e	5.20	5.72	0.205	0.225
L	19.81	20.32	.780	.800
L <sub>1</sub>		4.50		.177
ØP	3.55	3.65	.140	.144
Q	5.89	6.40	0.232	0.252
R	4.32	5.49	.170	.216
S	6.15	BSC	.242	BSC

### TO-268 Outline

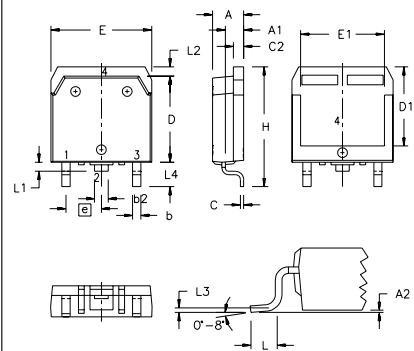

SYM	INCHES		MILLIMETERS	
	MIN	MAX	MIN	MAX
A	.193	.201	4.90	5.10
A <sub>1</sub>	.106	.114	2.70	2.90
A <sub>2</sub>	.001	.010	0.02	0.25
b	.045	.057	1.15	1.45
b <sub>2</sub>	.075	.083	1.90	2.10
C	.016	.026	0.40	0.65
C <sub>2</sub>	.057	.063	1.45	1.60
D	.543	.551	13.80	14.00
D <sub>1</sub>	.488	.500	12.40	12.70
E	.624	.632	15.85	16.05
E <sub>1</sub>	.524	.535	13.30	13.60
e	.215 BSC		5.45 BSC	
H	.736	.752	18.70	19.10
L	.094	.106	2.40	2.70
L <sub>1</sub>	.047	.055	1.20	1.40
L <sub>2</sub>	.039	.045	1.00	1.15
L <sub>3</sub>	.010 BSC		0.25 BSC	
L <sub>4</sub>	.150	.161	3.80	4.10

IXYS reserves the right to change limits, test conditions, and dimensions.

IXYS MOSFETs and IGBTs are covered by one or more of the following U.S. patents:

4,835,592 4,881,106 5,017,508 5,049,961 5,187,117 5,486,715 6,306,728B1 6,259,123B1 6,306,728B1  
4,850,072 4,931,844 5,034,796 5,063,307 5,237,481 5,381,025 6,404,065B1 6,162,665 6,534,343

**Fig. 1. Output Characteristics**  
**@ 25 Deg. C**

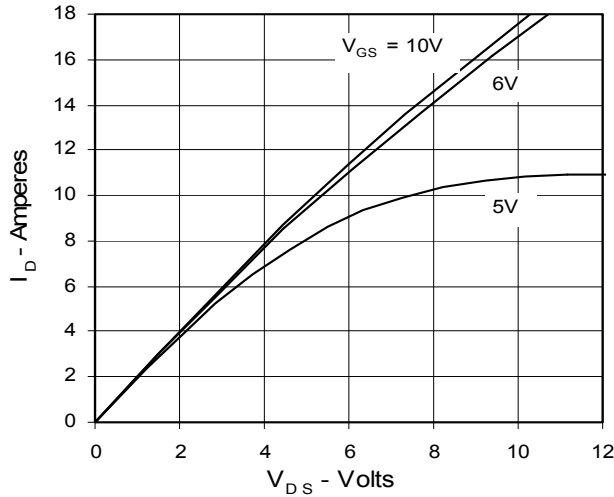

**Fig. 2. Extended Output Characteristics**  
**@ 25 deg. C**

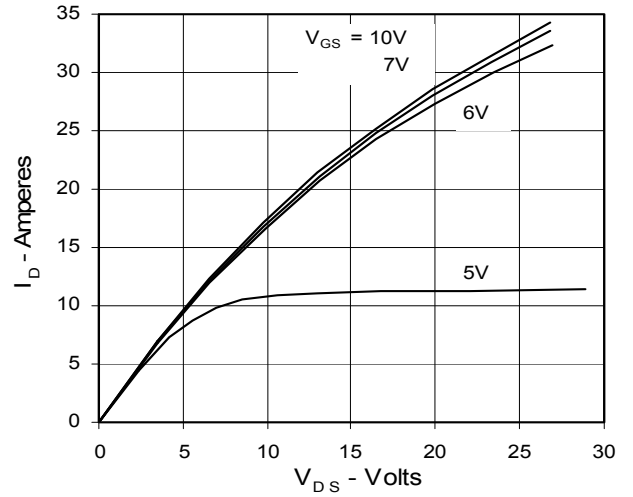

**Fig. 3. Output Characteristics**  
**@ 125 Deg. C**

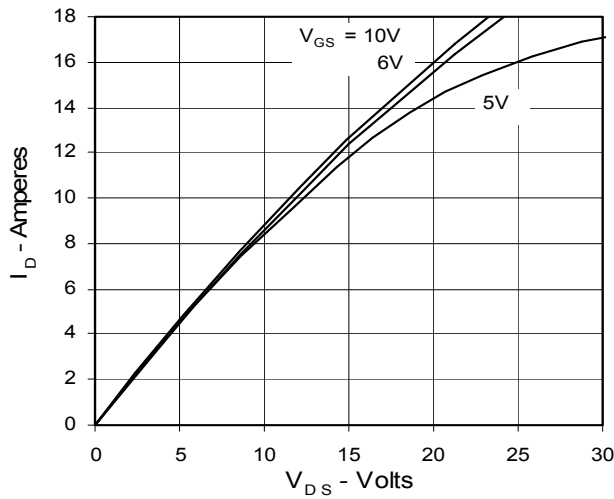

**Fig. 4.  $R_{DS(on)}$  Normalized to  $I_{D25}$  Value vs. Junction Temperature**

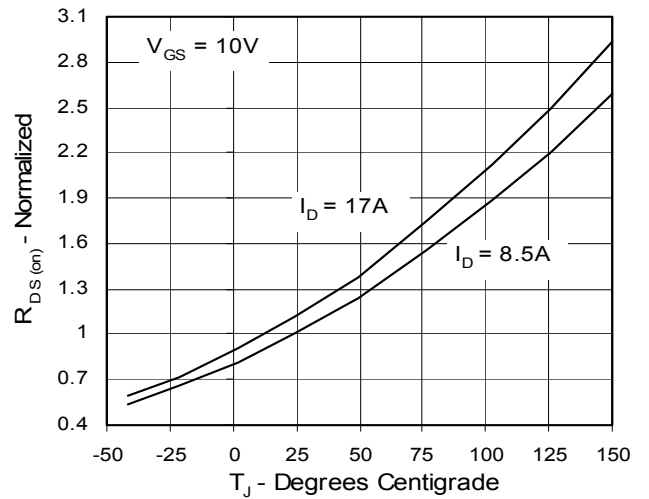

**Fig. 5.  $R_{DS(on)}$  Normalized to  $I_{D25}$  Value vs.  $I_D$**

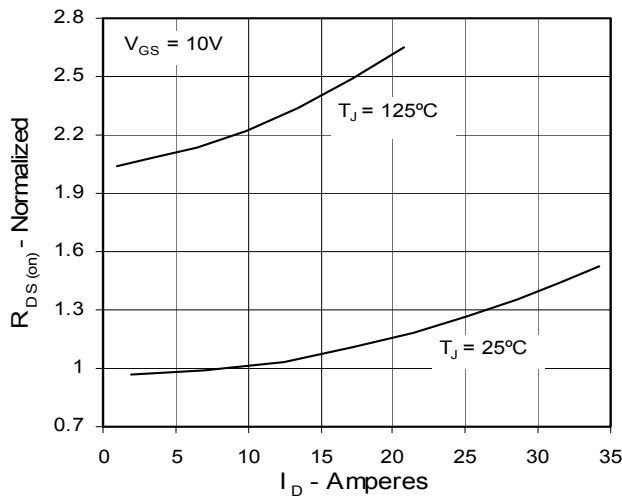

**Fig. 6. Drain Current vs. Case Temperature**

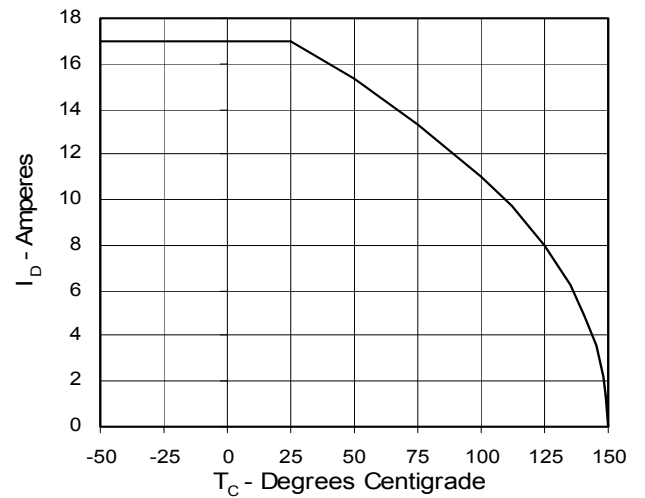

Fig. 7. Input Admittance

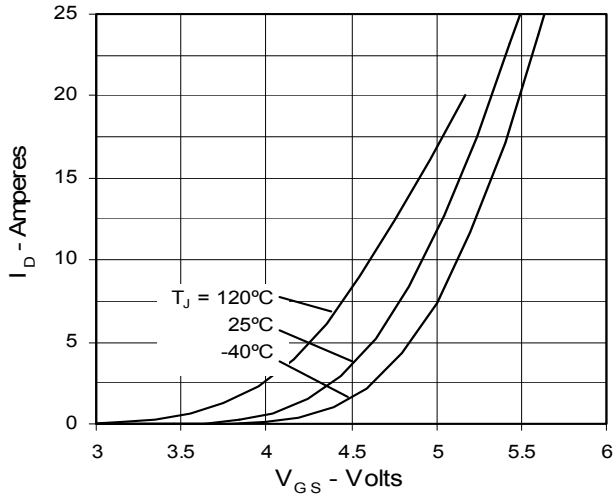

Fig. 8. Transconductance

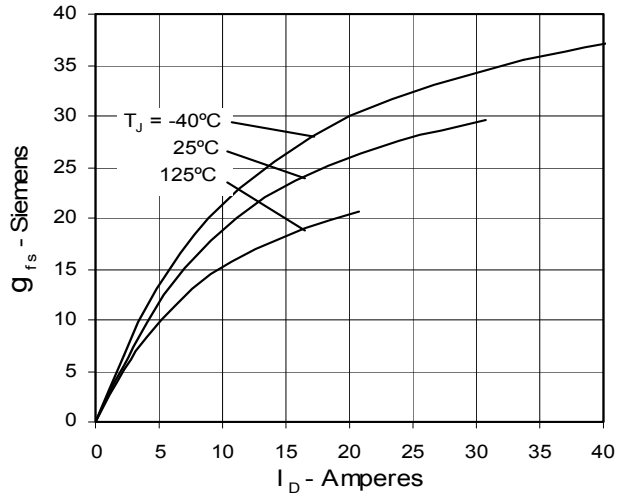

Fig. 9. Source Current vs. Source-To-Drain Voltage

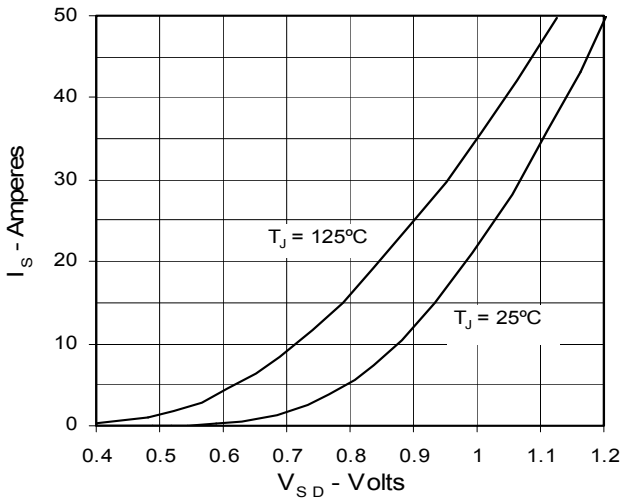

Fig. 10. Gate Charge

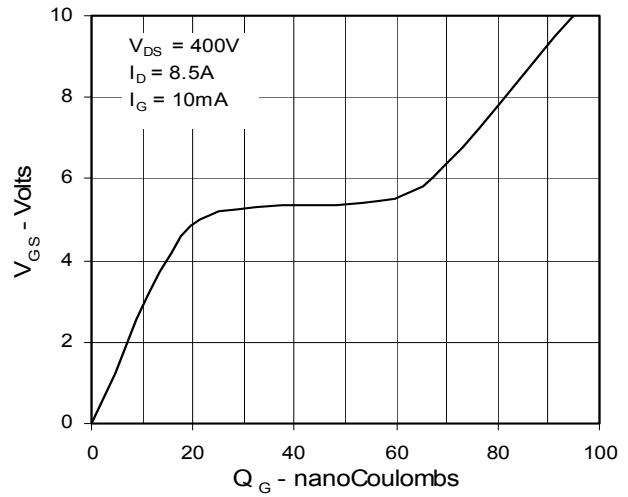

Fig. 11. Capacitance

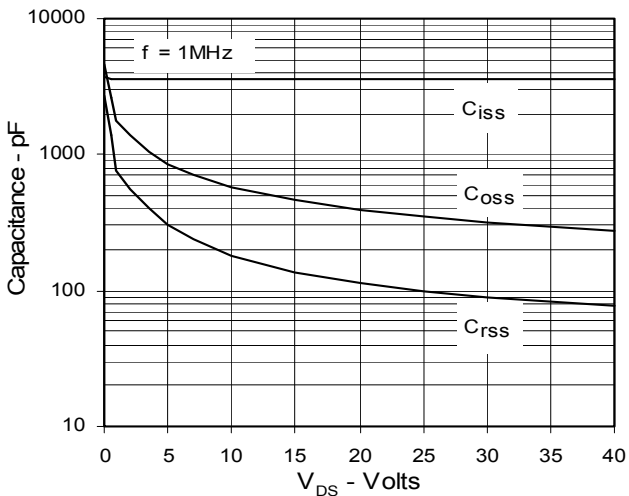
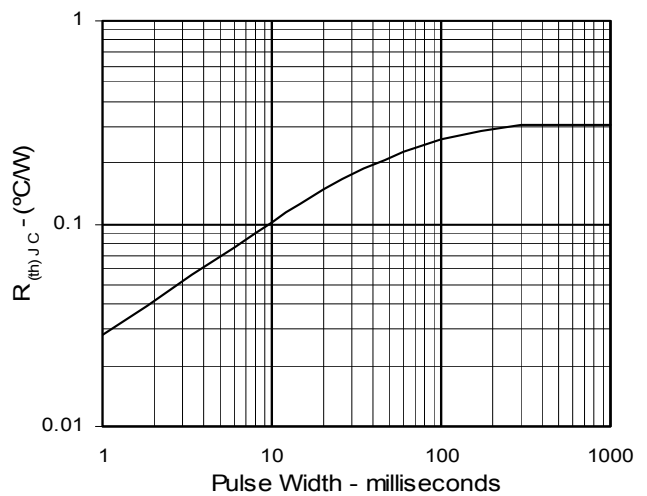

Fig. 12. Maximum Transient Thermal Resistance



IXYS reserves the right to change limits, test conditions, and dimensions.

IXYS MOSFETs and IGBTs are covered by one or more of the following U.S. patents:

4,835,592 4,881,106 5,017,508 5,049,961 5,187,117 5,486,715 6,306,728B1 6,259,123B1 6,306,728B1  
4,850,072 4,931,844 5,034,796 5,063,307 5,237,481 5,381,025 6,404,065B1 6,162,665 6,534,343