

LAYOUT INSPECTION

12

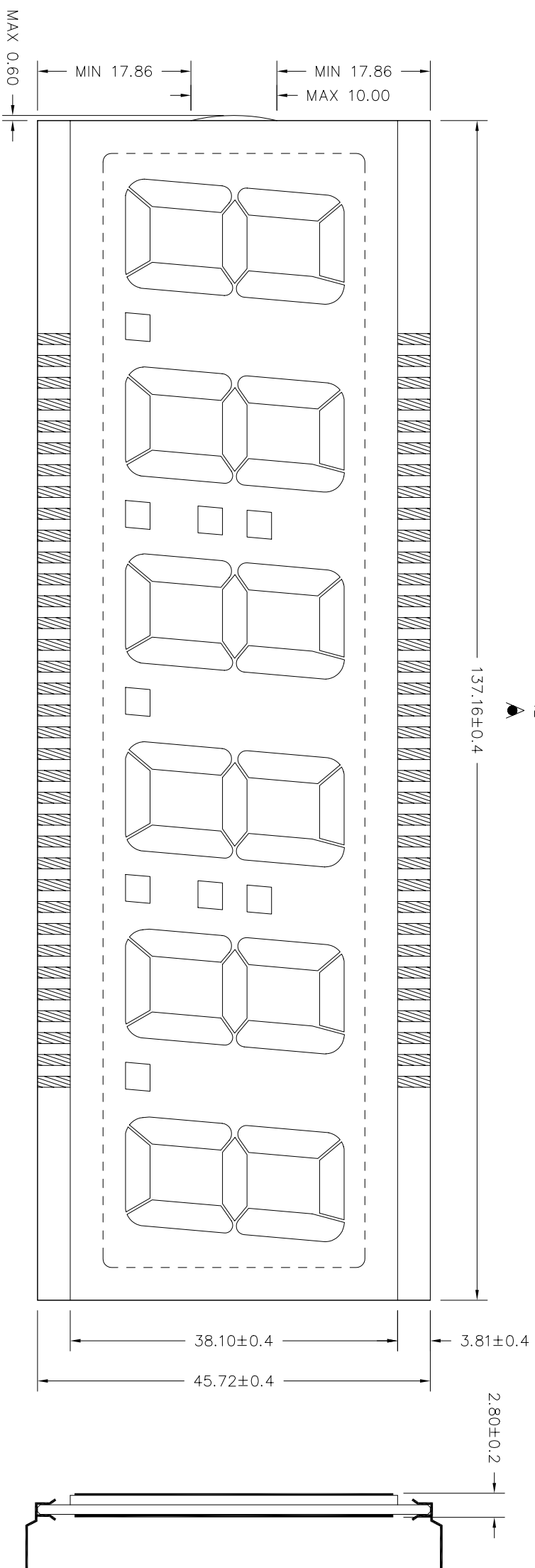

REMARKS: "◇" SPECIAL CHARACTERISTIC
 " + " SAFETY CHARACTERISTIC
 " () " REFERENCE ONLY

DWG/NO. : VARI-6111-10 REV : 0		VARI-TRONIX LTD.	
Dimension : mm	TOL : ±0.4 IF NOT SPECIFY	DO NOT SCALE DRAWING	
Drawn by : QMZ	SIGN :	3 rd ANGLE PROJECTION	
Checked by : YIN	SIGN :	Date : 2004-11-29	

DWG. NO.: VI-611-1 (REV.0)

(MAX 3.81)

(MIN V.A. 129.54)

(BEVEL EDGE(4X))

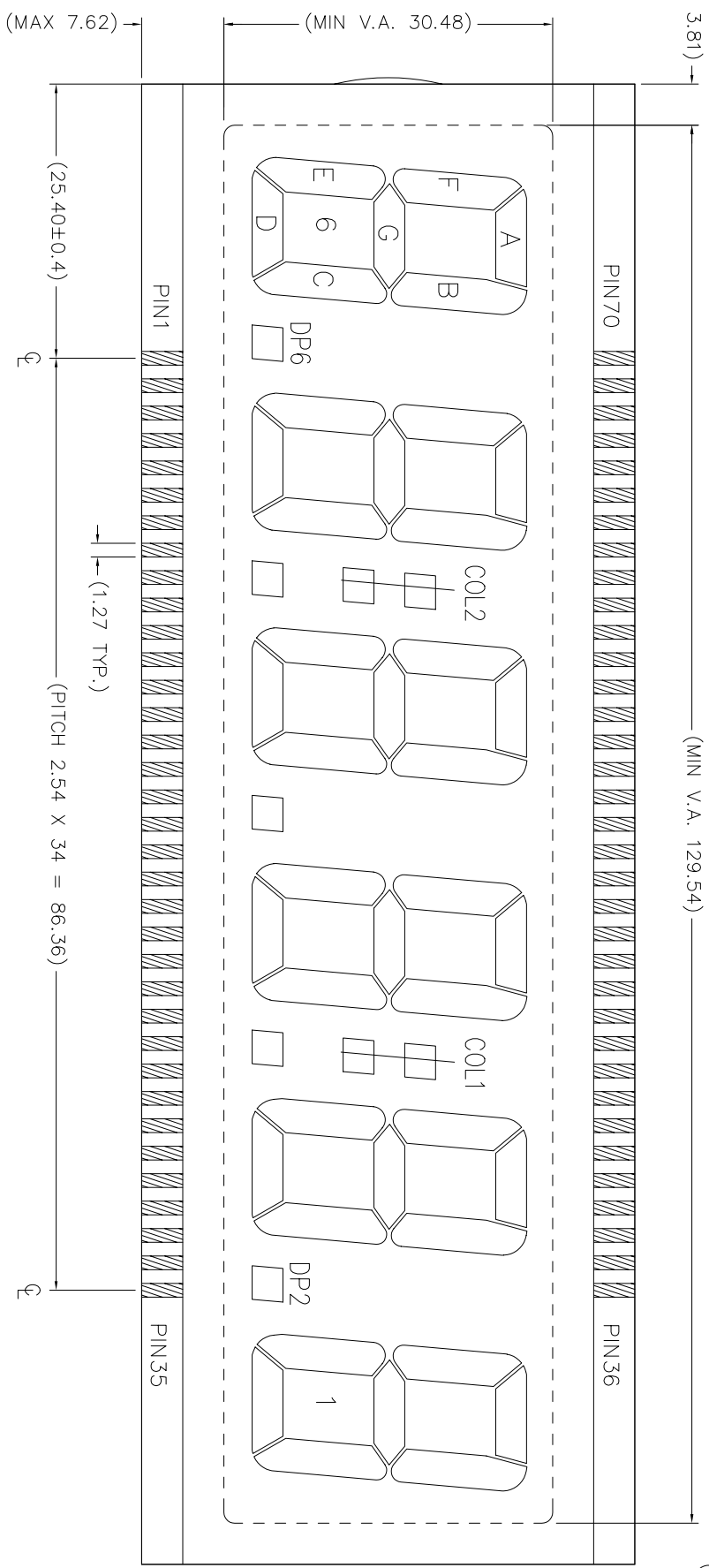

DWG. NO. : VI-611-1 (REV. 0)

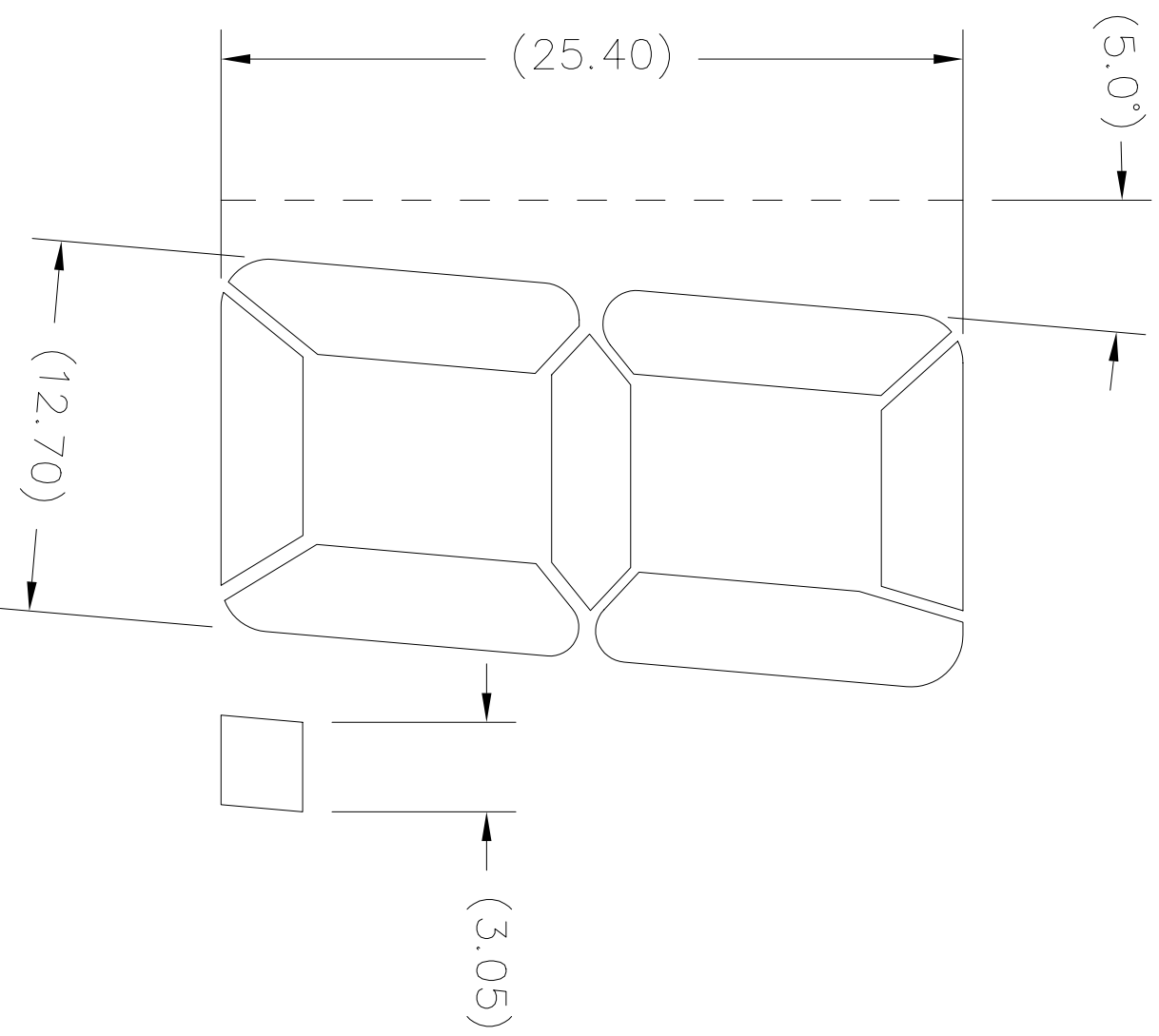

DIGIT 1 - 6

DWG. NO.: VI-611-1 (REV.0)

SEGMENT TRACKING

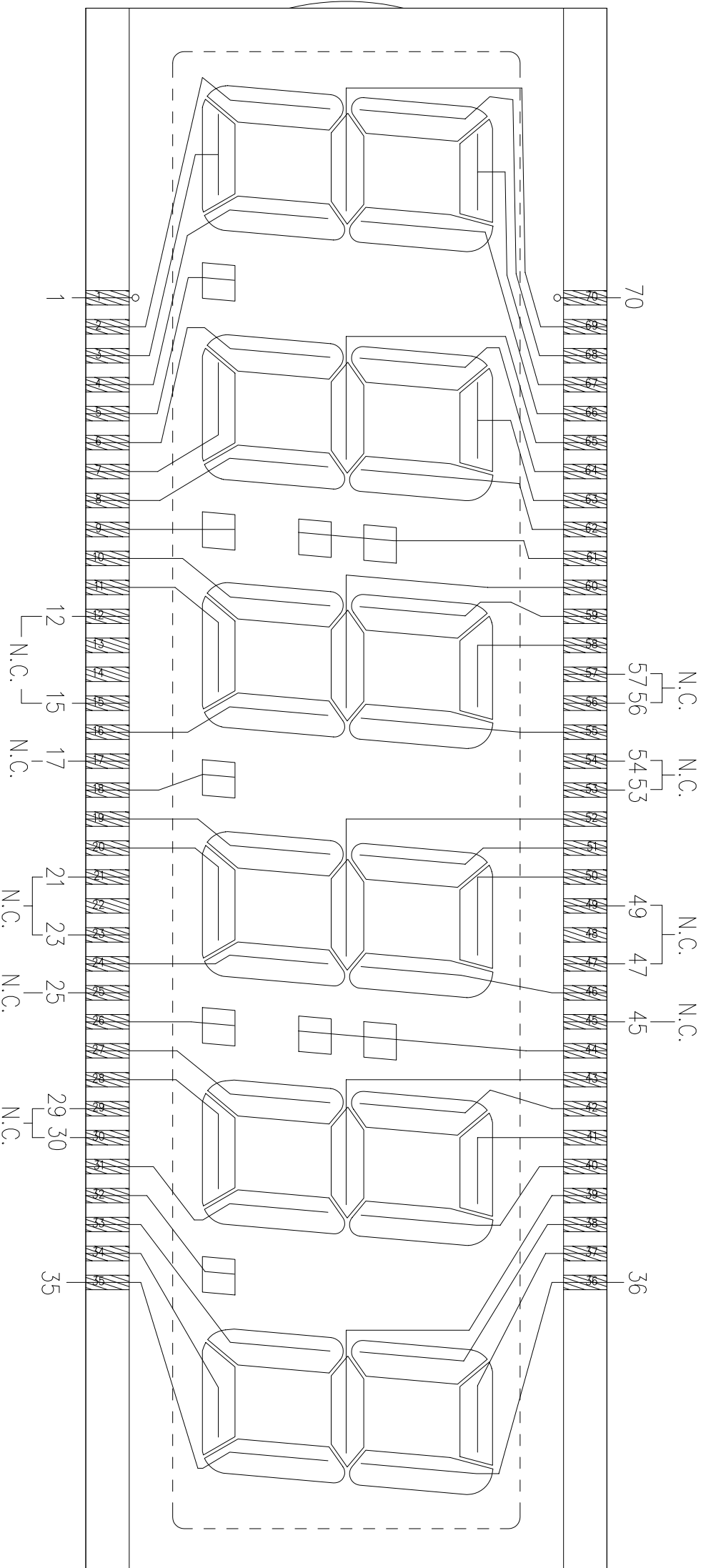

REMARKS: N.C. = NO CONNECTION

DWG. NO.: VI-611-1 (REV.0)

COMMON TRACKING

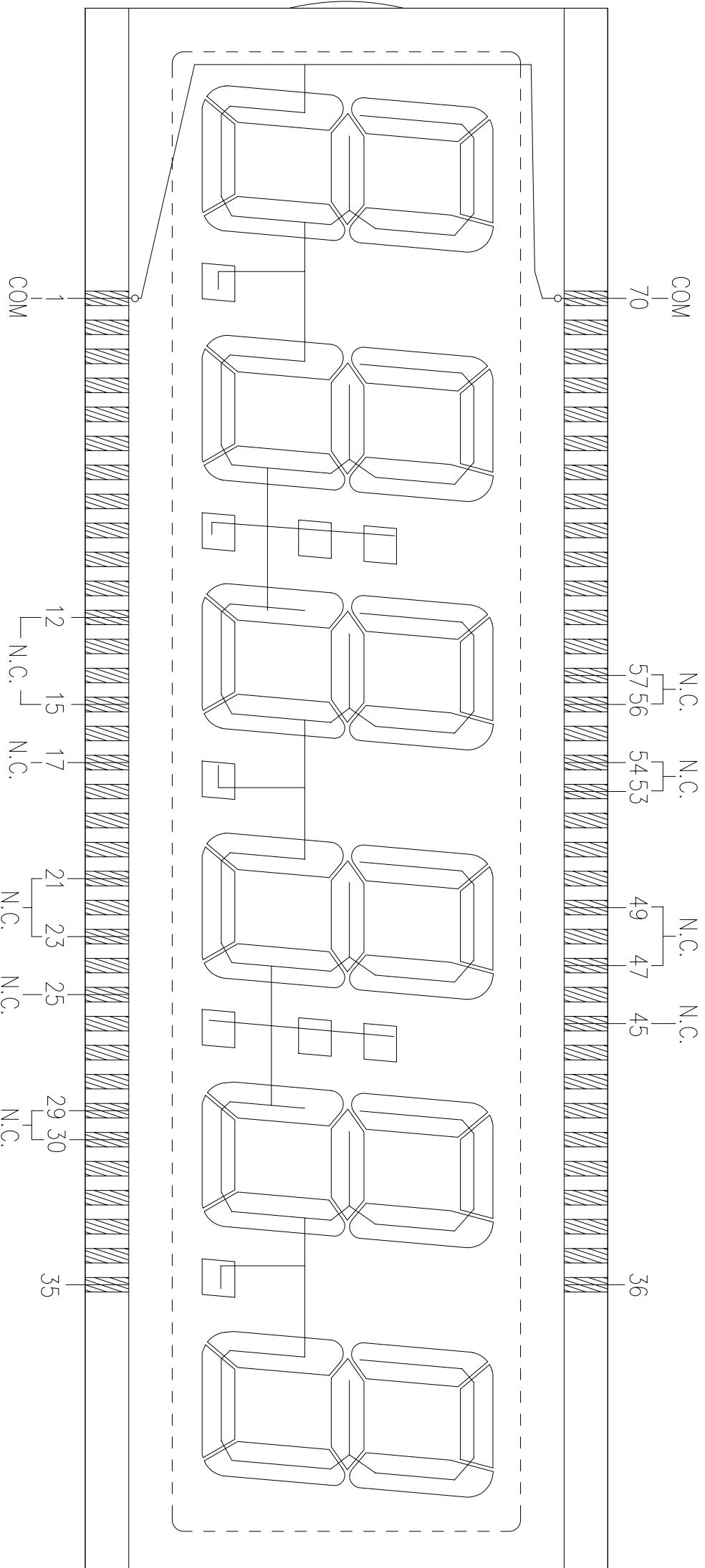

REMARKS : SAME COMMON SHOULD BE CONNECTED TOGETHER ON P.C.B.

N.C. = NO CONNECTION

VARTTRONIX LIMITED		OPEN LAYER :	SCALE
POLARIZER LOCATION DIAGRAM		P	Do not scale

DOC. NO. : PL-VI-611-1-01	Drawn by : QNZ	Date : 2004-12-02
	Checked by : INA	Date : 2004-12-02
	Approval by :	Date : 2004-12-02

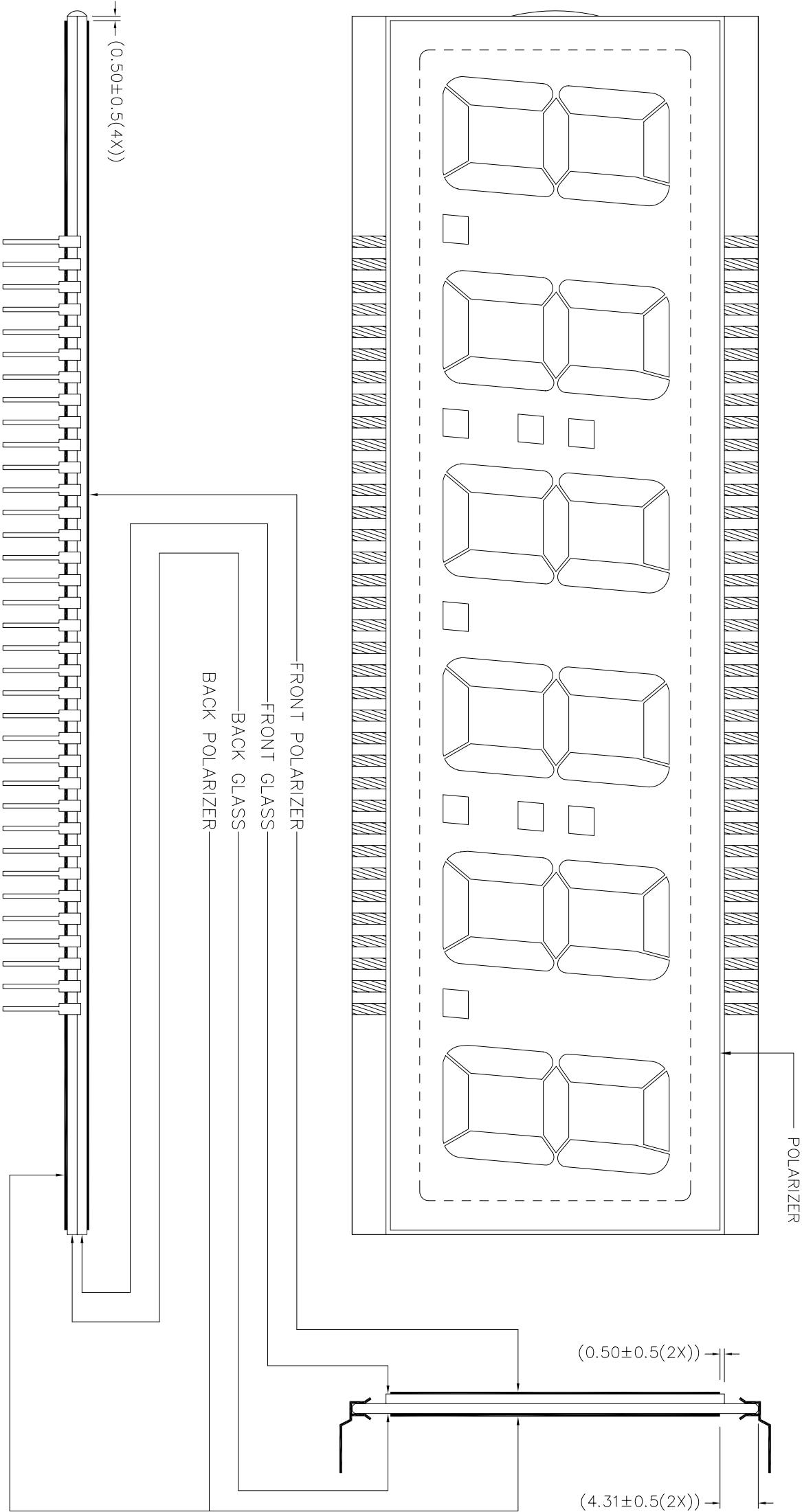

VARITRONIX LIMITED		OPEN LAYER : DP-L0	SCALE Do not scale
DIL-PIN DETAILS LOCATION DIAGRAM			
DOC. NO. : DP-VI-611-1-01	Drawn by : QM2	Date : 2004-11-29	
	Checked by : INA	Date : 2004-12-02	
ALL DIMENSIONS IN mm	Approval by :	Date : 2004-12-02	

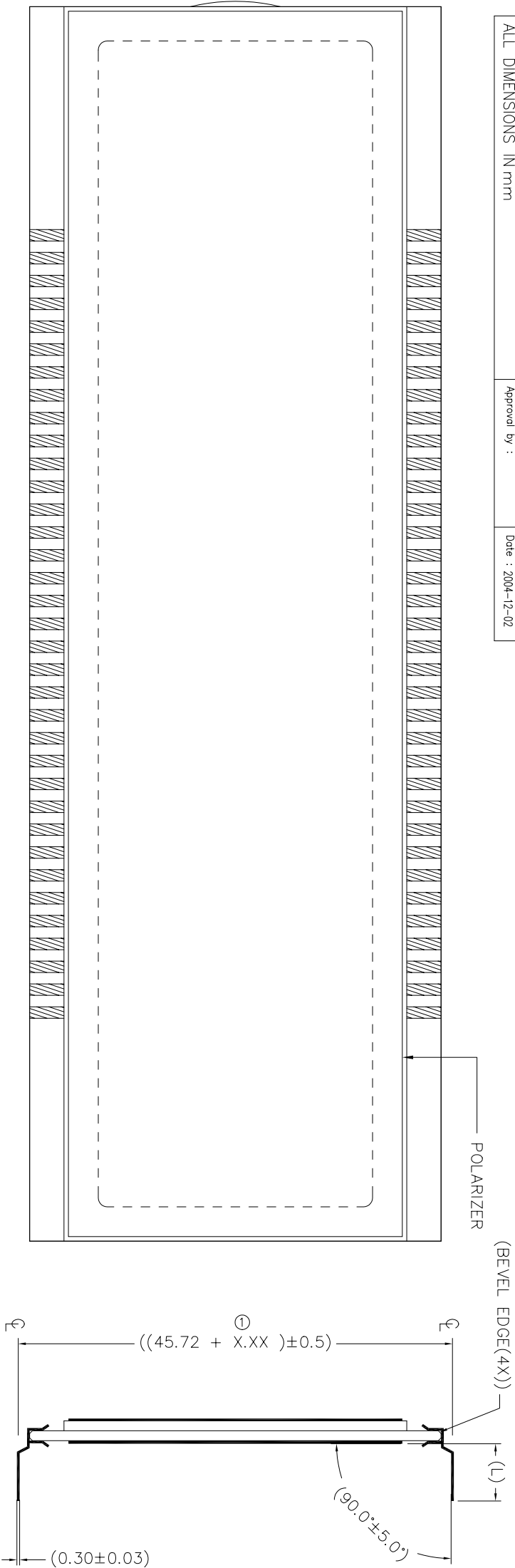

REMARKS: Ⓣ----- X.XX=2.54 (FOR PIN LENGTH > 3.2 & ≤ 10.00mm)
X.XX=1.75 (FOR PIN LENGTH > 10.00 & ≤ 19.50mm)
PIN LENGTH (L) REFER TO COVER PAGE

DWG.NO. : VI-611-1 (REV.0)

PIN	COM	PIN	COM	PIN	COM	PIN	COM
1	COM	19	3E	37	1A	55	4B
2	6E	20	3D	38	1F	56-57	N.C.
3	6D	21-23	N.C.	39	1G	58	4A
4	6C	24	3C	40	2B	59	4F
5	DP6	25	N.C.	41	2A	60	4G
6	5E	26	DP3	42	2F	61	COL2
7	5D	27	2E	43	2G	62	5B
8	5C	28	2D	44	COL1	63	5A
9	DP5	29-30	N.C.	45	N.C.	64	5F
10	4E	31	2C	46	3B	65	5G
11	4D	32	DP2	47-49	N.C.	66	6B
12-15	N.C.	33	1E	50	3A	67	6A
16	4C	34	1D	51	3F	68	6F
17	N.C.	35	1C	52	3G	69	6G
18	DP4	36	1B	53-54	N.C.	70	COM

REMARKS : SAME COMMON SHOULD BE CONNECTED TOGETHER ON P.C.B.
N.C. = NO CONNECTION